

Universal Boring And Facing Master Head

BORING CAPACITY Ø5-Ø250
FOR VERTICAL HOLE BORING IS Ø110

1 SCALE 0.01 mm per Ø



• Boring Bar
 PAGE C83

ORDER NO.	SHANK TYPE	DRAWBAR THREAD		Weight (kg)	CODE NO.
		S.A.E	METRIC		
VBHU-202	MT-3	1/2"-12W	M12X1.5P	6	3401-001
VBHU-203	MT-4	5/8"-11W	M16X2.0P	6.3	3401-002
VBHU-204	MT-5	1"-8W	M24X3.0P	7	3401-003
VBHU-205	R-8	7/16"-20UNF	n/a	6.2	3401-004
VBHU-206	NT-30	1/2"-12W	M12X1.75P	6	3401-005
VBHU-207	NT-40	5/8"-11W	M16X2.0P	6.2	3401-006
VBHU-208	NT-50	1"-8W	M24X3.0P	8.5	3401-007
VBHU-209	BT-40		M16X2.0P	6.9	3401-008
VBHU-210	C-25			4.5	3401-009
VBHU-211	SK-40		M16X2.0P	5.6	3401-010
VBHU-212	SK-50		M24X3.0P	8.3	3401-011
VBHU-213	BT-50		M24X3.0P	9.7	3401-012
VBHU-214	C-20			6	3401-013

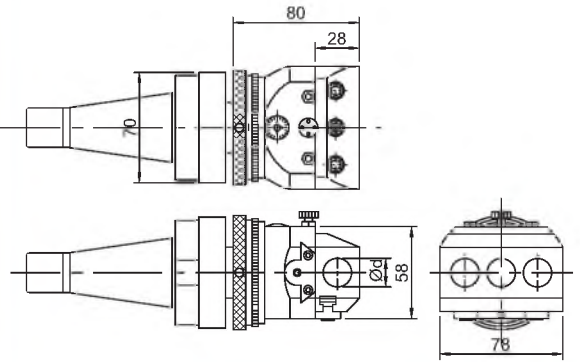



SPECIFICATION VBHU

Unit:mm

ACTUAL SIZE	OVERING BAR HOLE SIZE	BORING BAR HOLE SIZE	CENTER DIST BETWEEN HOLES.	CROSS HOLE DIA	OFFSET
78	100	18	23	18	15

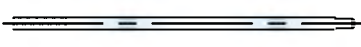
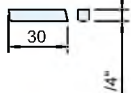
It is construction with precision parts, freedom of selection feeding quantity, auto feed and stop. Processing range from 5mm to 250mm.

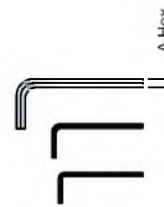
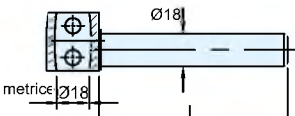
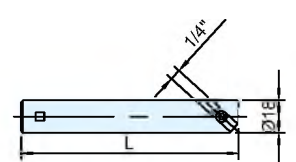
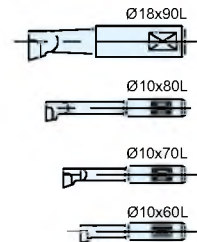
 <p>Stop Rod BP-17</p>	 <p>Square Bit(HSS) BP-18</p>	 <table border="1"> <thead> <tr> <th colspan="2">Clamping Sleeve</th> </tr> <tr> <th>metric</th> <th>D</th> </tr> </thead> <tbody> <tr> <td>BP-7</td> <td>Ø10</td> </tr> <tr> <td>BP-8</td> <td>Ø12</td> </tr> </tbody> </table>	Clamping Sleeve		metric	D	BP-7	Ø10	BP-8	Ø12																
Clamping Sleeve																										
metric	D																									
BP-7	Ø10																									
BP-8	Ø12																									
 <table border="1"> <thead> <tr> <th colspan="2">Allen Key</th> </tr> <tr> <th></th> <th>A</th> </tr> </thead> <tbody> <tr> <td>BP-14</td> <td>4</td> </tr> <tr> <td>BP-15</td> <td>5</td> </tr> <tr> <td>BP-16</td> <td>6</td> </tr> </tbody> </table>	Allen Key			A	BP-14	4	BP-15	5	BP-16	6	 <table border="1"> <thead> <tr> <th colspan="2">Boring Bar</th> </tr> <tr> <th>metric</th> <th>L</th> </tr> </thead> <tbody> <tr> <td>BP-21</td> <td>104</td> </tr> </tbody> </table>	Boring Bar		metric	L	BP-21	104	 <table border="1"> <thead> <tr> <th colspan="2">Boring Bar</th> </tr> <tr> <th>metric</th> <th>L</th> </tr> </thead> <tbody> <tr> <td>BP-1</td> <td>90</td> </tr> <tr> <td>BP-2</td> <td>120</td> </tr> </tbody> </table>	Boring Bar		metric	L	BP-1	90	BP-2	120
Allen Key																										
	A																									
BP-14	4																									
BP-15	5																									
BP-16	6																									
Boring Bar																										
metric	L																									
BP-21	104																									
Boring Bar																										
metric	L																									
BP-1	90																									
BP-2	120																									
<table border="1"> <thead> <tr> <th colspan="2">Boring Bar</th> </tr> <tr> <th>metric</th> <th>ØxL</th> </tr> </thead> <tbody> <tr> <td>BP-9</td> <td>Ø18x90</td> </tr> <tr> <td>BP-10</td> <td>Ø10x80</td> </tr> <tr> <td>BP-11</td> <td>Ø10x70</td> </tr> <tr> <td>BP-12</td> <td>Ø10x60</td> </tr> </tbody> </table> 	Boring Bar		metric	ØxL	BP-9	Ø18x90	BP-10	Ø10x80	BP-11	Ø10x70	BP-12	Ø10x60														
Boring Bar																										
metric	ØxL																									
BP-9	Ø18x90																									
BP-10	Ø10x80																									
BP-11	Ø10x70																									
BP-12	Ø10x60																									