

Super Open Drill Vise

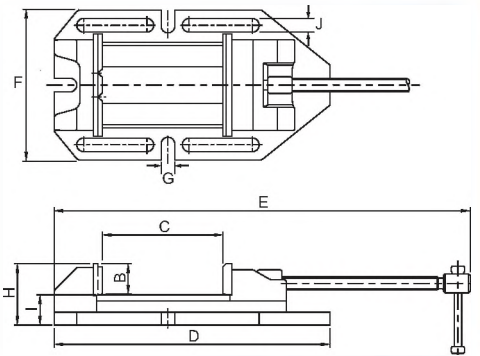

EURO TYPE

NEW



- Big opened.
- Big clamping capacity.
- With prisma jaw for round workpiece.
- For drilling & milling using.



Unit:mm

ORDER NO.	A	B	C OPEN	D	E	F	G	H	I	J	V	MAX.Clamp Force kgf	G.W. (kgs)	CFT (cm)	CODE NO.
VRV-4	110	32	130	316	471	179	16	73	40	16	5-32	450	9.8	32.3 x 13.3 x 12.9	1002-320
VRV-5	135	40	160	366	552	207	16	81	40	16	6-40	650	14.0	32.3 x 13.3 x 12.9	1002-321
VRV-6	160	50	220	447	693	247	16	96	45	16	7-48	900	25.7	32.3 x 13.3 x 12.9	1002-322

Free Vise

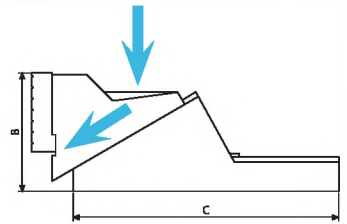
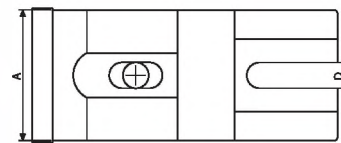
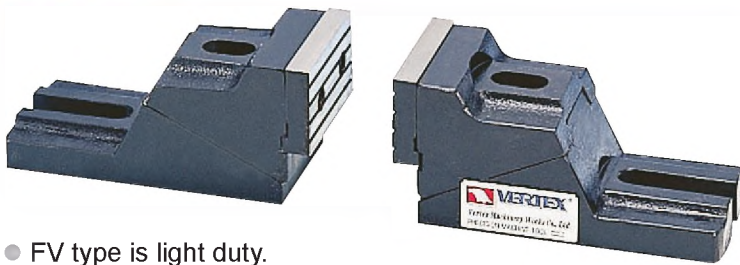

- FV type is light duty.
- Free style clamping For big workpiece.
- Adjustable distance 15mm For clamping.



Unit:mm

ORDER NO.	DIMENSION (WxHxL)	CLAMPING CAPACITY (HxL)	ACCESSORIES BOLT SIZE	MAX.Clamp Force kgf	WEIGHT (kgs/2PCS)	CODE NO.
FV-350	75x67x150mm	140x350mm	M12 x 75L x 2PCS. M12 x 125L x 2PCS	900	7.5	1002-290
FV-450	100x90x200mm	180x450mm	M12 x 75L x 2PCS. M12 x 125L x 2PCS	900	14	1002-291
FV-550	125x120x250mm	250x550mm	M16 x 75L x 2PCS. M16 x 125L x 2PCS	900	23	1002-292

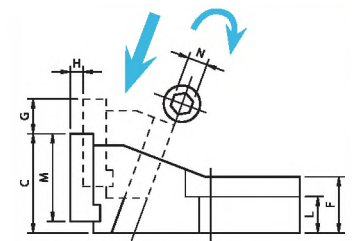
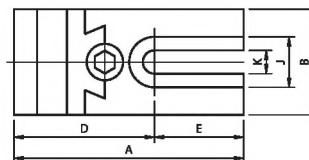
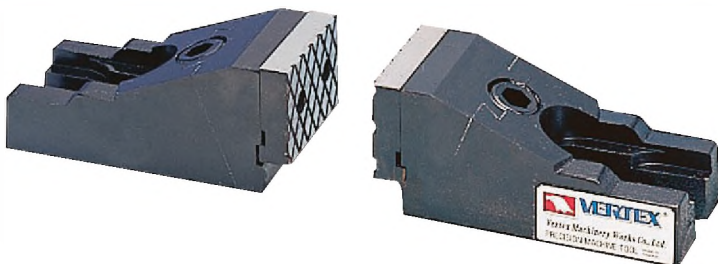

- Free style clamping For big workpiece.
- Heavier duty.
- Adjustable distance 10mm For clamping.



Unit:mm

ORDER NO.	A	B	C	D	E	F	G	H	J	K	L	M	N	MAX.Clamp Force kgf	ACCESSORIES BOLT SIZE	N.W. (kgs)	CODE NO.
SV-62	139	64	59.5	85	54	33.5	21	9	30.5	18	22	52.5	12	1800	M12 x 75L x 4PCS	5.8	1002-293
SV-85	192	86.5	86	115	77	53	24	10	36	18	25.5	59.5	12	1800	M16 x 75L x 4PCS	11	1002-294
SV-125	218	127	84	124	94	51.5	33	18	45.5	20	23.5	73	12	1800	M16 x 75L x 4PCS	21	1002-295